

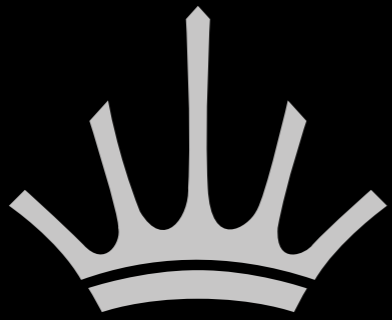

E65S GbW

UNMATCHED CONTROL





THE KING OF GRINDERS



GRINDING INNOVATIONS

FUELED BY A PASSION FOR WORLD CLASS COFFEE.

Our mission at Mahlkönig is to support passionate coffee enthusiasts and professionals with innovative grinding solutions to raise coffee enjoyment to the next level. For several generations, we have been combining our valuable brand heritage with top-level engineering and our understanding of market requirements to shape the trends of tomorrow.

We are driven by our motivation to develop the latest technology, tailored to individual needs for optimal workflow at every coffee bar. We work to the highest quality standards, leaving nothing to a chance. Therefore, we rely exclusively on in-house engineering and production, especially when it comes to the burrs, the heart of the grinder. Engineered for outstanding performance, durability and reliability, all Mahlkönig products deliver the maximum value in use.

As "The King of Grinders" we are passionate about pioneering the world of grinding alongside our customer's requirements. Our superb premium grinders combine the latest high-tech innovations with state-of-the-art engineering and design. They are manufactured to ensure excellent accuracy, perfect quality in the cup and the greatest achievable taste, creating the ultimate experience in coffee enjoyment.

E65S GbW

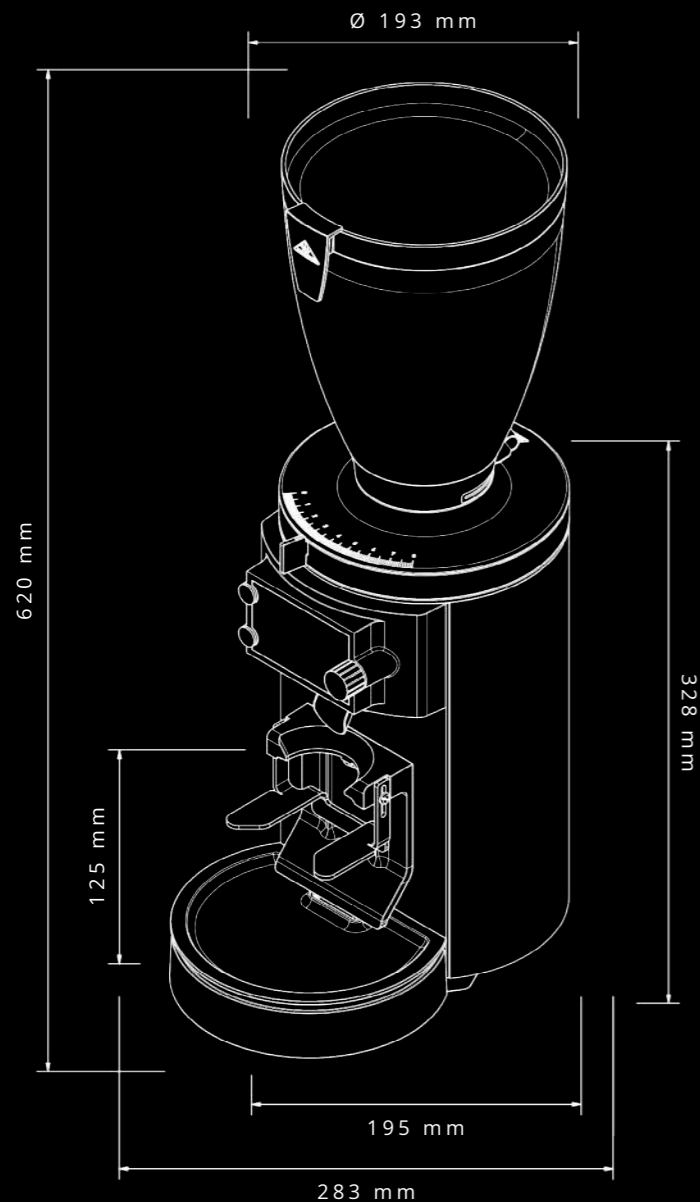

- modern slim design
- indestructible bean hopper
- quick and easy grind adjustment
- high-definition 88.3 mm display
- intuitive user interface
- Disc Distance Detection**
- proven premium grinding profile
- Grind-by-Weight technology**
- real time weight control**
- high performance motor
- innovative temperature control
- near-silent grinding
- adjustable and removable spout
- comfortable cleaning and maintenance concept

KEY FEATURES





*"Serving the customers a great taste experience with every single cup is what running a coffee shop is all about. The E65S GbW makes it possible by providing the most accurate and consistent doses, ever.
Let's grind by weight – **because every gram matters.**"*

BEN PUT | Barista Champion | Roastery & Coffee Shop Owner



EVERY GRAM MATTERS

The revolution of espresso grinding: Grind-by-Weight.

Demanding coffee shop owners are constantly striving for a consistent first-class product quality. Together we aim to serve the customer with an outstanding taste experience in every single cup. The E65S GbW makes it possible – and hence becomes the first choice for quality-aware professional baristas around the world.

When you dose by either volume or by a preset timer, the chosen degree of fineness or the condition of the coffee, can create fluctuations, resulting in unreliable extractions and taste experiences.

Mahlkönig's Grind-by-Weight technology always produces the perfect quantity required – ground exactly according to your settings. This is how the E65S GbW sets itself apart from any other grind-by-weight model on the market.

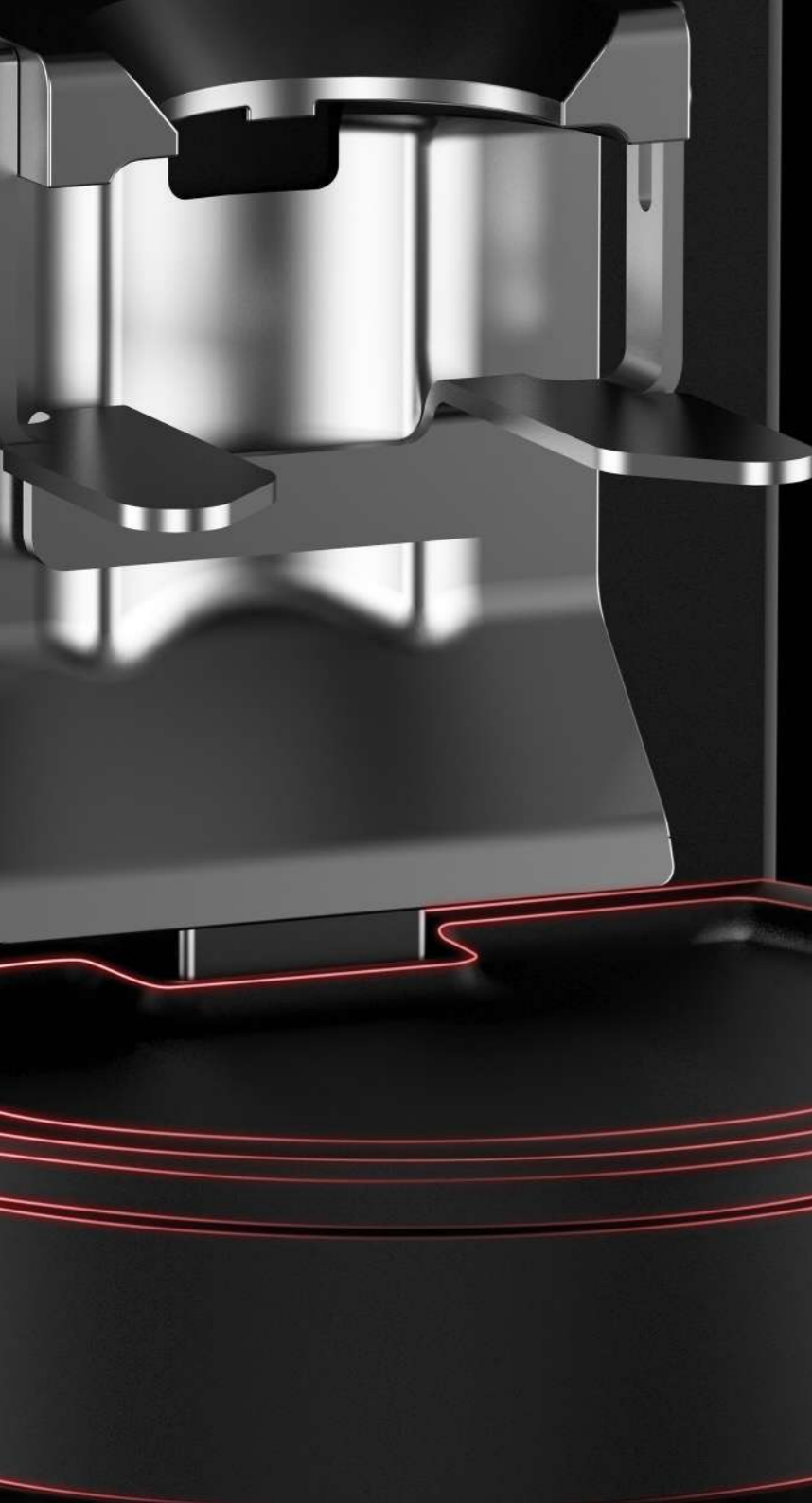

Unmatched control: fast, absolutely precise and consistent weight-based grinding.

The E65S GbW is equipped with an integrated high-precision load cell which weighs the grounds 6000 times per second during the grinding process. This is the first time ever, that an espresso grinder offers real time weight control.

The ultimate grind adjustment with Disc Distance Detection.

The innovative Disc Distance Detection (DDD) function lets you set the degree of fineness with the utmost precision and perfection.

This is the first espresso grinder to feature grind adjustments based on the actual distance between the burrs. The indication allows a precision of 0.001 mm and ranges from 180 to 600 μm . Keeping the perfect individual grinder settings for your espresso has never been so easy, yet so precise.

Time savings and quality assurance through automated dosing.

The integrated Portafilter Detection recognizes the portafilter automatically, selects the corresponding grinding preset and starts the grinding process. This way, the barista gains valuable time for the preparation. Furthermore, the easy application reduces training requirements for the staff. Dosing mistakes get prevented and your coffee expenditure gets reduced.





**At the heart of the grinder:
premium grinding technology.**

When it comes to manufacturing the centerpiece of grinding technology, we leave nothing to chance. Hence, we keep the engineering and production departments for our burrs exclusively in-house.

Whilst continuously analyzing recent and upcoming market requirements, our engineers use their expertise and skills to shape the innovative spirit of Mahlkönig. Using the latest computer-controlled technology, each burr acquires its individual shape and finishing touch under the watchful eyes of our experienced production team in Hamburg.

For almost 100 years, Mahlkönig has been compiling a comprehensive catalog of different tooth profiles and grinding surface patterns, allowing us to select the perfect set of espresso burrs for the E65S GbW. Manufactured from high-quality hardened steel, each set of burrs lasts for approx. 1000 kg of beans, depending on the roast. The sophisticated design of the 65 mm burrs guarantees optimal particle size, allowing the espresso to release its full taste and aroma.



The precious aroma of your beans is protected by our innovative motor temperature control.

Mahlkönig's engineering team has equipped the motor of the E65S GbW with a ground-breaking temperature control. The smart construction is designed to create an airflow taking in fresh air that cools down the motor continuously. An additional fan gets activated when the E65S GbW is grinding higher loads, in order to prevent your espresso beans from suffering from any possible negative influence by rising temperatures.

Even under heavy-duty laboratory tests, where the E65S GbW was used to grind 100 shots straight, the temperature of the ground coffee never reached the 50-degree mark.

The motor is designed to handle high workloads:

Max. nominal power	ON/OFF	Duty Cycle (DC)
220-240 V 50/60 Hz	5 s ON / 15 s OFF	25 % DC S3*1 (20 s)
100 V 50/60 Hz	5 s ON / 25 s OFF	16.7 % DC S3*1 (30 s)
110-127 V 60 Hz	4 s ON / 26 s OFF	13.3 % DC S3*1 (30 s)

Performance (DS*2 = 20 g)

3 DS*2/min

2 DS*2/min

2 DS*2/min

*1 S3: Intermittent periodic duty
*2 DS: Double shot

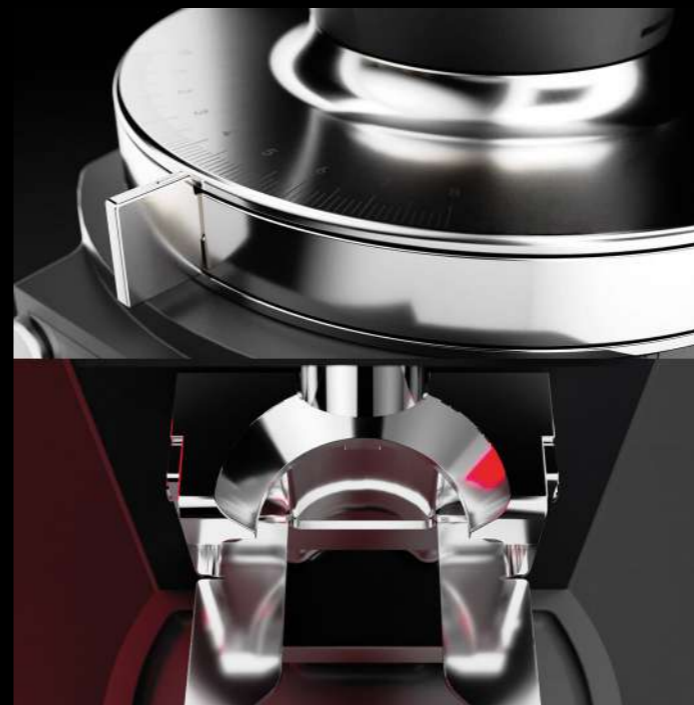

Pioneering grind-adjustment technology lets you set and keep the perfect degree of fineness.

The ultrafine thread inside the grind-adjustment mechanism of the E65S GbW enables the utmost precision when it comes to obtaining the right degree of fineness for your espresso beans. The adjustment range spans 180 to 600 µm, whilst the 80 step indicating scale offers meticulous repeatability. An auto-lock system keeps the adjustment in place. However, to ensure the setting doesn't get changed unintentionally, there an additional dial on the back of the grinder to lock the perfect degree of fineness if required.

Our revolutionary spout, designed for perfectly-centered espresso grinding.

The re-designed spout adapts to every portafilter within seconds by being simply pushed or pulled into place. Made from specially selected anti-static material, honed into a uniquely effective shape, it allows the grounds to flow very fluffy into the portafilter.

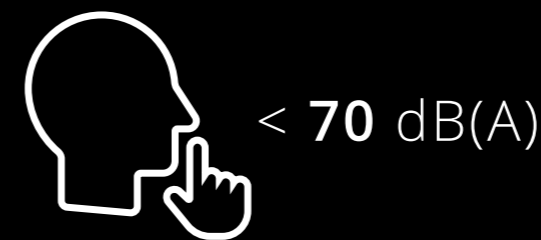

Grinding has never sounded so good.

We all want our customers to fully enjoy espresso without disturbance. With this in mind, a team of Mahlkönig engineers and acoustics experts developed the body of the E65S GbW with a strong focus on noise reduction and frequency optimization. The sturdy grinder housing, foam-insulated side covers and a special foil behind the front cover, all help to reduce and deepen the grinding sound to below 70 dB(A).



18.0 g

Optimal operation.

The E65S GbW is equipped with a premium 88.3 mm color display, providing the highest visual comfort when setting your grinder or when checking statistics and service intervals.

Intuitive use on the next level.

The control functions of the E65S GbW enable rapid navigation through the menu. The innovative software is based on state-of-the-art technology and features modern user-friendly icons. You can set your preferred recipe within seconds and be ready to grind.



The perfect match for any espresso bar.

The slimline body design with its compact footprint brings outstanding grinding quality even to the smallest of bars. However, with its modern style and clean look the E65S GbW can equally shine like a star on your spacious counter, demonstrating first-class grinding quality and modern design.

Whether you are in need of a premium espresso grinder to fit into a very small space or you are looking for an eye-catching highlight to complete your brewing stage: the E65S GbW is made for you.

Polished aluminum, matte black

Polished aluminum, matte black & white



Absolutely indestructible: the bean hopper

The new ultra-robust bean hopper of the E65S GbW is practically unbreakable. Relying on screws instead of adhesive, the bean hopper and adapter will never come apart during use and the integrated finger protection inside the bean hopper guarantees user safety. Simply fill it with up to approx. 1200 g of beans and start grinding. If required, two optional sizes of bean hopper are available - the smaller approx. 250 g unit or the larger approx. 1800 g version. The standard 1200 g hopper features our new smart clip on the lid that can be used to hold a note - for example, an information card for the customer to learn more about the coffee or brewing/recipe instructions to be kept in mind by the barista.

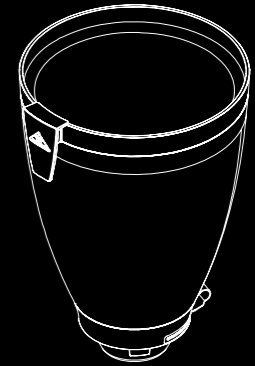

Perfectly adaptable: the portafilter holder

The rock steady portafilter holder is incredibly simple to adjust by loosening and tightening just two screws, allowing it to fit any portafilter with ease. Its sturdy stainless steel construction will neither bend nor bow. This, along with the robust start-stop button, guarantee trouble-free use, even during the busiest of rush hours.

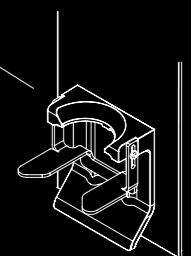

Clean bar counter: the drip tray

The drip tray with its optimal size, shape and position help to keep your bar clean and free from unwanted grounds. Held in place by two strong magnets it self-adjusts and easily slips into position, making it simple to detach, clean and put back into place.

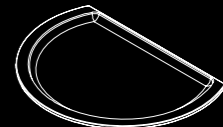

TECHNICAL DETAILS

Voltage // frequencies // phases // nominal power	220-240 V // 50/60 Hz // 1~ // 440 W 110-127 V // 60 Hz // 1~ // 580 W 100 V // 50/60 Hz // 1~ // 550/700 W
Idle speed	1400 rpm (50 Hz) 1700 rpm (60 Hz)
Burr diameter	65 mm
Burr material	Special steel
Average grinding capacity*	50 Hz: 4-5 g/s @ 250 µm 60 Hz: 5-6 g/s @ 250 µm
Bean hopper capacity	approx. 1200 g
Dimensions (w x h x d)	19.5 x 62 x 28.3 cm
Dimensions of packing (w x h x d)	69.7 x 28.7 x 47.5 cm
Net weight	12.2 kg
Gross weight	14 kg
Certifications	CE, CB, ETL Safety, ETL Sanitation
Standards	Conforms to IEC/EN 60335-1 IEC/EN 60335-2-64 Certified to UL 763 CSA C22.2 No. 195 NSF/ANSI 8
Standard colors	Polished aluminum, matte black Polished aluminum, matte black & white
Special equipment (bean hopper)	approx. 250 g or approx. 1800 g

*Depends on the grinding goods and the chosen degree of fineness. | All measured values under laboratory conditions.
Other electric specifications available on request. | Subject to change without prior notice.





www.mahlkoenig.com | www.hemrogroup.com